

## 1470 nm laser diode - DFB

Model 1 : >10 mW / singlemode fiber / 14 pin Butterfly package

Reference: 1470LD-1-0-0-1 or 2 (SMF or PM)

Technology : DFB\*

SPECIFICATIONS	Unit	Min	Typ	Maximum
Output Power (CW mode)	mW	10		
Output Power (Pulse mode)	mW		15	
Center Wavelength (CW)**	nm	1465	1470	1475
Spectral Width (FWHM)	kHz		1 000	2 000
Threshold Current	mA		8	20
Operating Current	mA		60	70
Operation Voltage	V		1.6	1.8
Wavelength shift w Temperature	nm/°C		0.08	
Wavelength shift w Current	nm/mA		0.003	
Side mode suppression ratio	dB	35	50	
Internal Photodiode Responsivity	mA/W	5		
Internal Photodiode Dark Current	nA			500
TEC current (-5/60°C)	A			1
TEC Voltage (-5/60°C)	V			1.5
Internal thermistor (25°C)	kOhm	9.5	10	10.5
Fiber type	PM1550 or equivalent			
Coating diameter	µm		900	
Fiber bend radius	mm			30
Storage case temperature	°C	-40 (abs min)		70 (abs max)
Case operating temperature	°C	-20		60
Lead soldering temperature	°C		260	300
Laser diode reverse voltage	V			15
Pigtail termination	FC/APC connector			
Polarization state (if PM version)	Aligned to the slow axis			

\*: See our tutorial : [fiber coupled laser diode](#)

Form factor & Laser diode pinning (standard 14-pin Butterfly Type-1) :

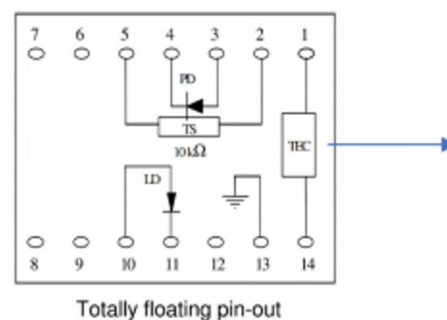
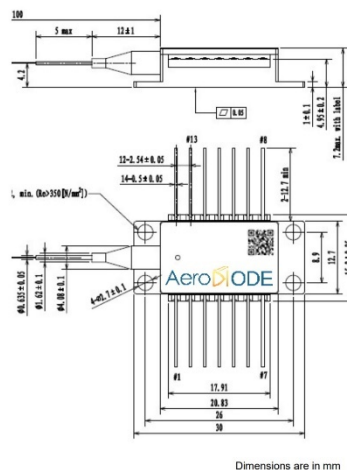

NOTE : Other pin configuration available on demand (Type-2, Type-2 Bias-T etc.)

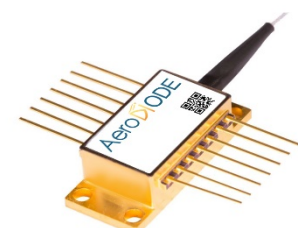

## 1470 nm laser diode - DFB

Model 2 : >40 mW / singlemode fiber / 14 pin Butterfly package

Reference: 1470LD-2-0-0-1 or 2 (SMF of PMF)

Technology : DFB\*

SPECIFICATIONS	Unit	Min	Typ	Maximum
Output Power (CW mode)	mW	40		
Output Power (Pulse mode)	mW		60	
Center Wavelength (CW)	nm	1465	1470	1475
Spectral Width (FWHM)	kHz		160	200
Threshold Current	mA		8	20
Operating Current	mA		300	350
Operation Voltage	V		1.6	1.8
Wavelength shift w Temperature	nm/°C		0.08	
Wavelength shift w Current	nm/mA		0.003	
Side mode suppression ratio	dB	35	50	
Internal Photodiode Responsivity	mA/W	5		
Internal Photodiode Dark Current	nA			500
TEC current (-5/60°C)	A			1
TEC Voltage (-5/60°C)	V			1.5
Internal thermistor (25°C)	kOhm	9.5	10	10.5
Fiber type	PM1550 or equivalent			
Coating diameter	µm		900	
Fiber bend radius	mm	30		
Storage case temperature	°C	-40		70
Case operating temperature	°C	-20		60
Lead soldering temperature	°C	255	260	265
Laser diode reverse voltage	V			15
Pigtail termination	FC/APC connector			
Polarization state (PM version)	Aligned to the slow axis			

\*: See our tutorial : [fiber coupled laser diode](#)

Standard form factor & Laser diode pinning (standard 14-pin Butterfly Type-1) :

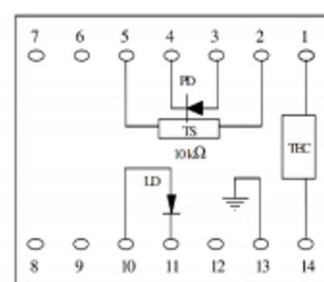
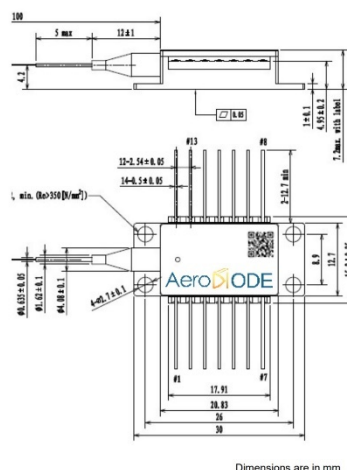

Totally floating pin-out

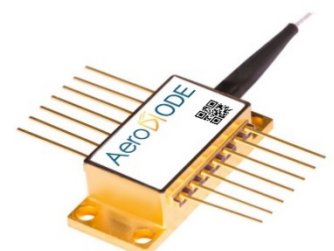

NOTE : Other pin configuration available on demand (Type-2, Type-2 Bias-T etc.)

## 1480 nm laser diode

Model 3 : >400 mW / singlemode fiber / 14 pin Butterfly package

Reference: 1480LD-3-0-0-2 (PM only)

Technology : Fabry-Perrot with Bragg\*

SPECIFICATIONS	Unit	Min	Typ	Maximum
Output Power (CW mode – kink free)	mW	400		
Output Power (Pulse mode)	mW		>600	
Center Wavelength (CW)	nm	1479	1480	1481
Spectral Width (FWHM)	nm		1	2
Threshold Current	mA		70	120
Operating Current	mA		1300	
Operation Voltage	V		1.6	2.0
Wavelength shift w Temperature	nm/°C			0.015
Side mode suppression ratio	dB	35	50	
Internal Photodiode Responsivity	mA/W	None		
Internal Photodiode Dark Current	nA	None		
TEC current (-5/60°C)	A		1	
TEC Voltage (-5/60°C)	V		2.2	
Internal thermistor (25°C)	kOhm	9.5	10	10.5
Fiber type (PM only)	PM1550 or equivalent			
Coating diameter	µm		250	
Fiber bend radius	mm	16		
Storage case temperature	°C	-40		85
Case operating temperature	°C	-5		70
Lead soldering temperature	°C		260	300
Laser diode reverse voltage	V			2
Pigtail termination	Ferrule only or FC/APC			
Polarization state	Aligned to the slow axis			

\*: See our tutorial : [fiber coupled laser diode](#)

Form factor & Laser diode pinning (standard 14-pin Butterfly Type-1) :

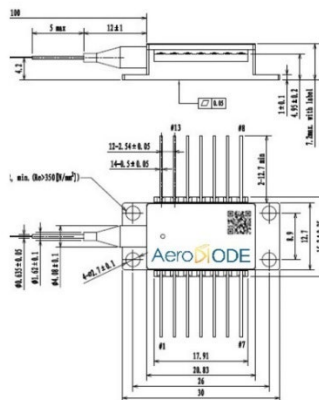

Dimensions are in mm

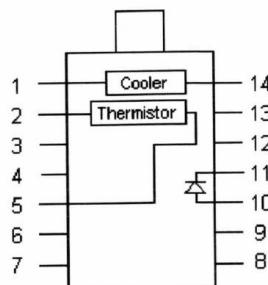

1	Cooler (+)	14	Cooler (-)
2	Thermistor	13	Case ground
3	NC	12	NC
4	NC	11	Lase Cathode
5	Thermistor	10	Laser Anode
6	NC	9	NC
7	NC	8	NC

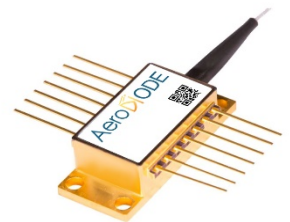

## 1470 nm laser diode

30 W / Fiber : 105  $\mu$ m-core / NA=0.22

Reference: 1470LD-4-0-0

SPECIFICATIONS	Unit	Min	Typ	Maximum
Output Power	W	30		
Center Wavelength	nm	1460	1470	1480
Spectral Width (FWHM)	nm		20.0	
Threshold Current	A		0.3	
Operating Current	A			9
Operation Voltage	V			25
Conversion Efficiency	%		16	
Wavelength shift w Temperature	nm/°C		0.3	
Wavelength shift with current	nm/A		1	
Slope Efficiency	W/A		3.8	
Back reflection isolation stage	nm	1020		1200
Back reflection isolation	dB		30	
Storage Temperature	°C	-30		70
Case Operating Temperature	°C	15	25	45
Minimum Fiber Bend Radius	mm	30		
Fiber Buffer/tube Diameter	$\mu$ m		900	
Fiber Clad Diameter	$\mu$ m		125	
Fiber Core Diameter	$\mu$ m		105	
Numerical Aperture	NA		0.22	
Soldering Temperature	°C			260
Soldering time	s			10
Dimensions	mm	80*80*24.8		
Mounting holes diameter/distance	mm	Ø3.3 / 74.4 ; 38		
Fiber connector		Yes (SMA905)		
ROHS Compliant		Yes		

Please solder the pins when the level of current is over 6A

